



Thank you for your purchase of EchoStreams OSS316-D5 Storage Server System!

1. Check the Content of the box. Please confirm that your package contains the following:

#	Description	Image / Description	Qty
1	OSS316S-D4 Enclosure		1
2	Motherboard	Tyan S7100GM2NR	1
3	CPU and memory	Intel Skylake and DDR4	Opt.
4	IO Cards		Opt.
5	Heatsink		2
6	2x 2.5" Drive Bay		Opt.
7	4x 2.5" Drive Bay		Opt.
8	Slide Rail Kit + Screws		1 set
9	Power Cable*		2
10	Serial Cable*		1

* Inside the accessories box. Box may consist of screw sets for rail kit or drives. If any items are missing, please contact your reseller or sales rep.

2. Get Familiar with the Unit.

OSS316-D5 is a storage server supporting dual Intel V5 processor and front tray-less 16x 3.5" HDDs, optional rear 2x and 4x 2.5" drive bays in a 3U space. Tyan S7100GM2NR motherboard, and internal cabling are preinstalled. IO cards, CPU, and memory can be preinstalled upon request.

Front view of the unit

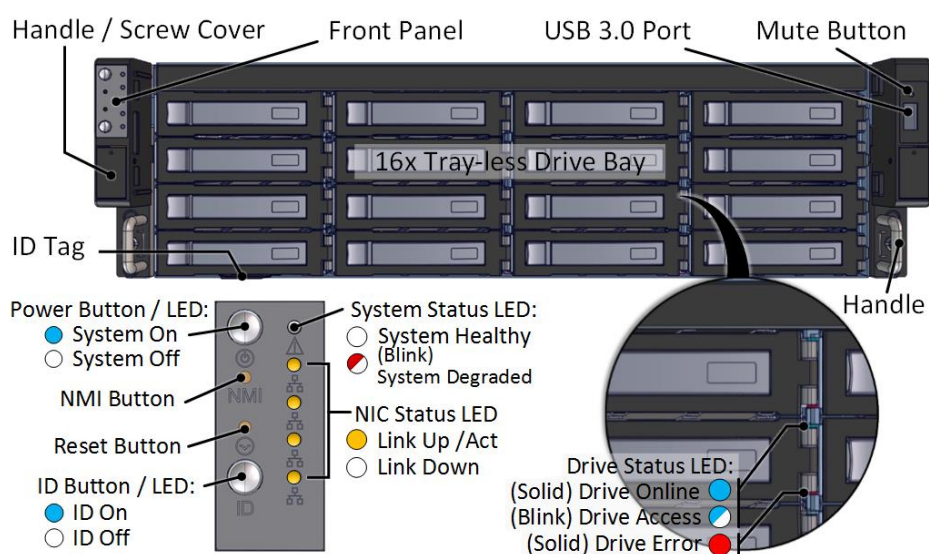

Rear view of the unit

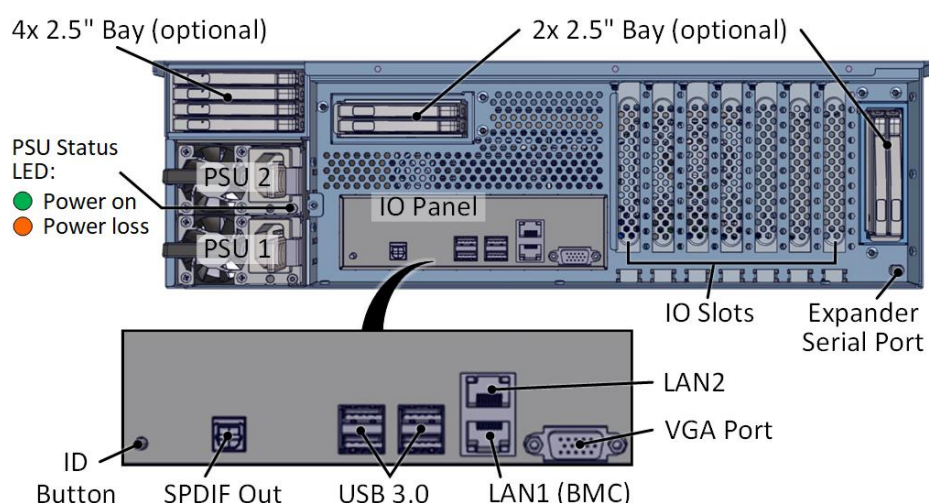

3. Remove the Top Covers of the unit as follows:

First, remove the middle cover:

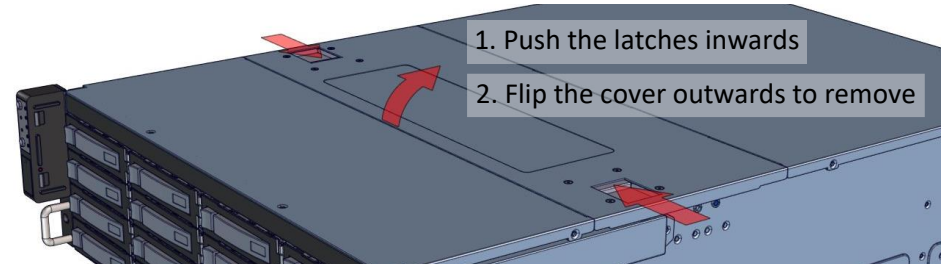

Proceed to remove the motherboard cover:

1. Remove two screws (red circles)

2. Slide the motherboard cover backwards to remove

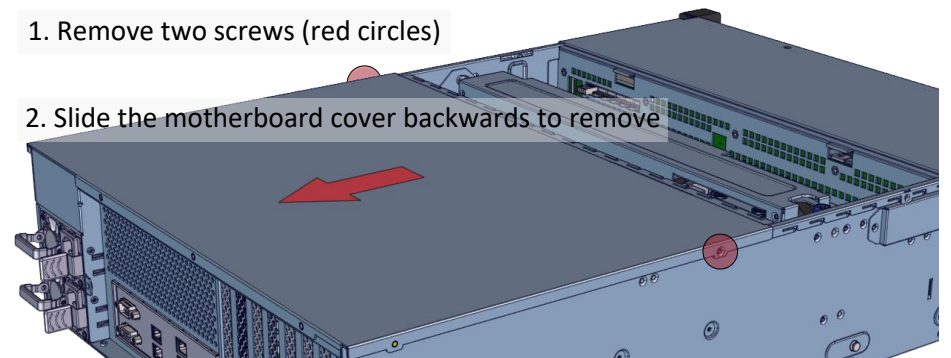

4. Inspect the Inside of the unit.

Internal components comprise of a Tyan motherboard, an expander board, optional rear 2x and 4x 2.5" bays, 4x internal fan modules (electronically attached to the motherboard).

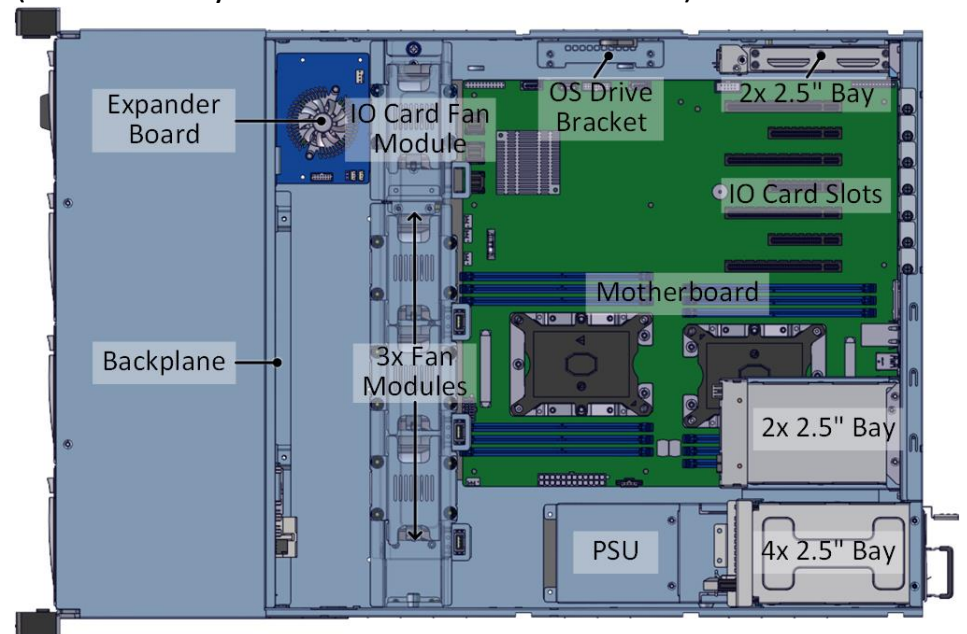

To install OS disk(s), a space for 2 OS disks is available on the left inner wall of the chassis.

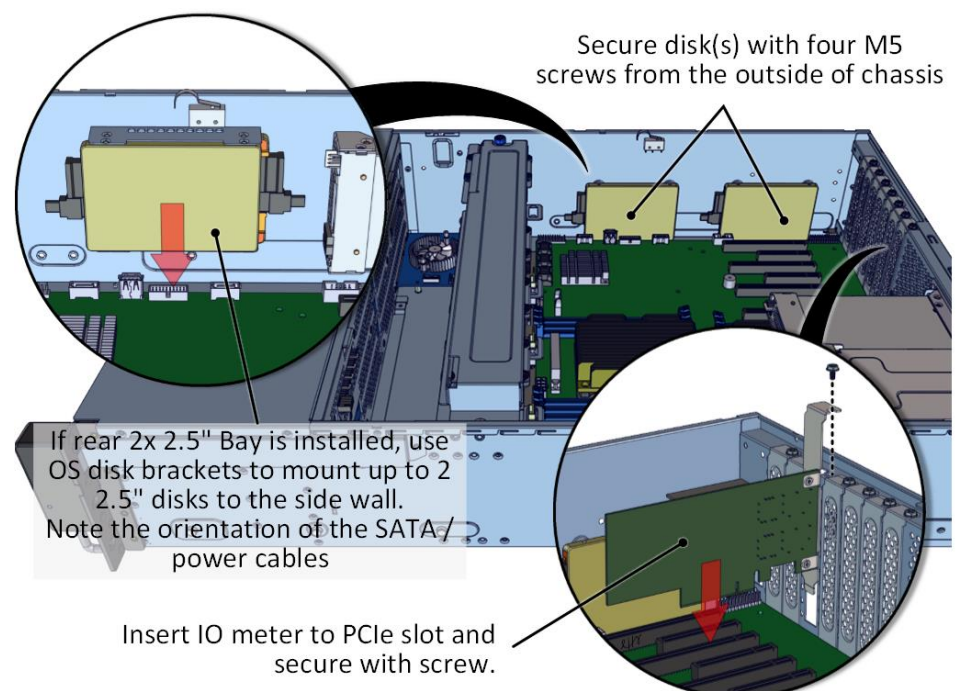

Installation and service of this product should be conducted by a trained personnel to avoid bodily injury from electric shock or heavy object



Observe ESD (Electrostatic Discharge) practices during integration to avoid possible damage to the board and / or other components

5. Install Motherboard Components (CPU, heatsink, memory) using the guidelines below. For further details, refer to the motherboard TPS.

- Support Intel Xeon Skylake Processor Family
- 2x LGA3647 Sockets
- Max up to 205W TDP
- Intel C621 PCH Chipset

- 6+6 DDR4 RDIMM/LRDIMM 2666
- Up to 384GB RDIMM / 768GB LRDIMM / 1536GB RDIMM 3DS
- 6 Channels per CPU, 1.2V
- Populate from A0 → F0

- PCIe1, PCIe3 (Gen3x16), PCIe2 (Gen3x8) f/ CPU0
- PCIe5, PCIe7 (Gen3x16), PCIe4, PCIe6 (Gen3x8) f/ CPU1

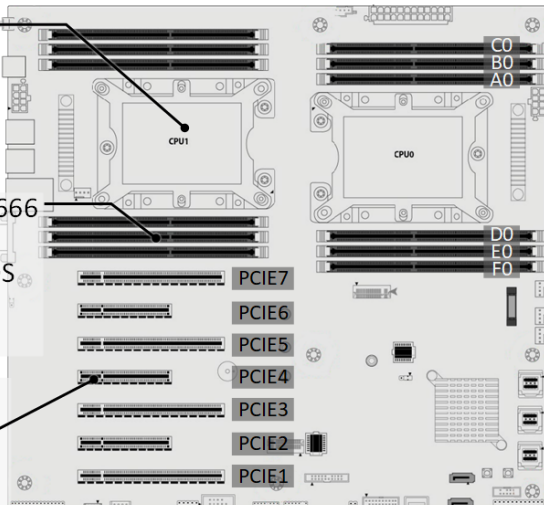

6. Remove the Inner Rail from the slide rail.

- 1-2 Pull the inner rails out. Pull the blue release tab when it hits a stop.
- 3-4 Keep extending inner rail and pull the white detach tab when it hits the second stop

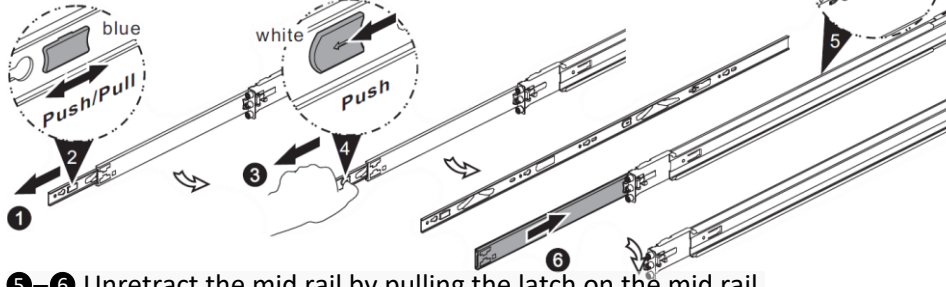

- 5-6 Unretract the mid rail by pulling the latch on the mid rail

7. Install Inner Rails to the enclosure.

Yellow circles are for standoff screws

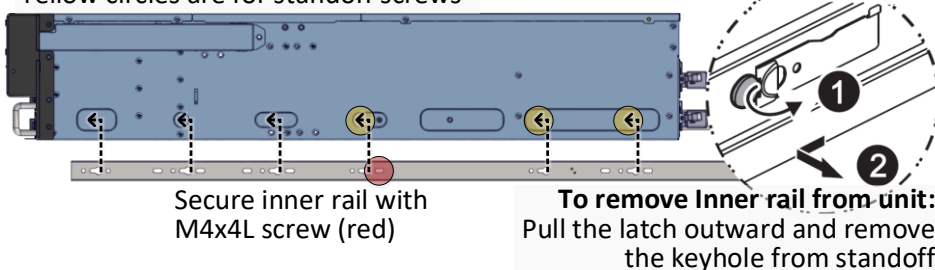

8. Install the Outer Rails to the Rack as follows:

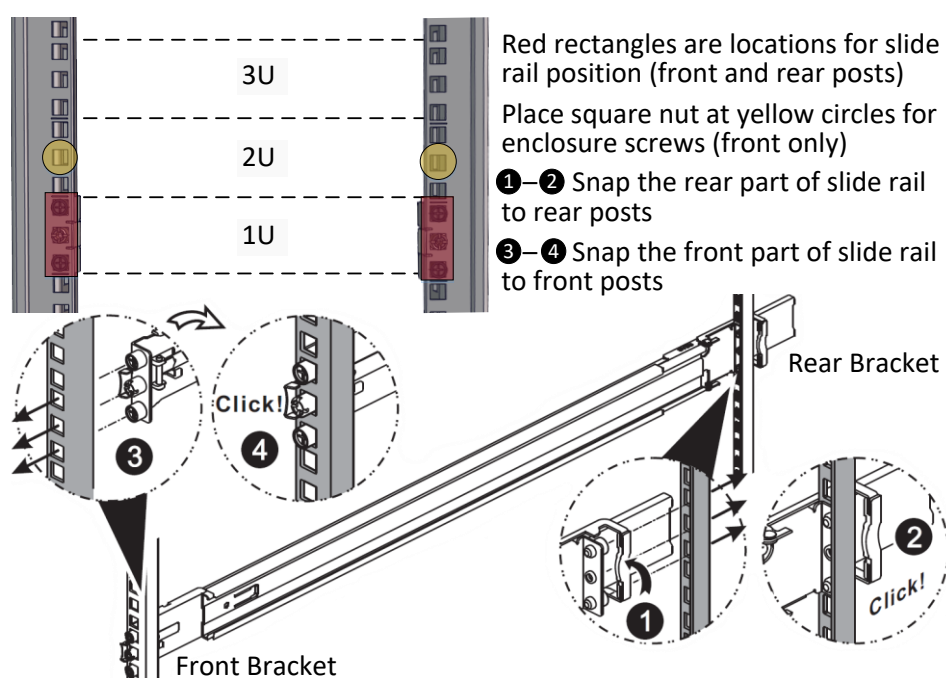

To remove slide rails, use the latches to undo the assembly as follows:

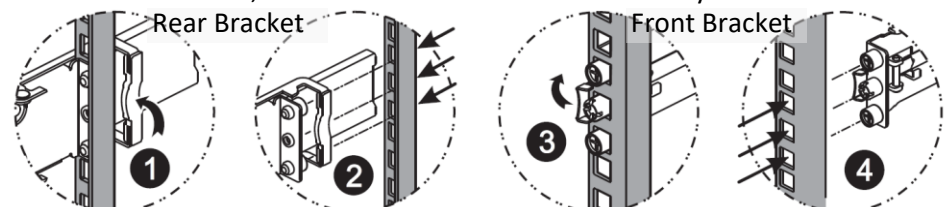

9. Install the Unit to the Rack as follows:

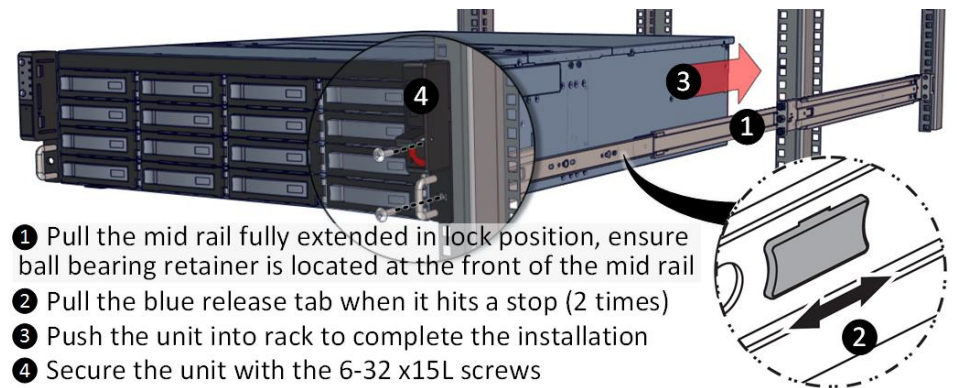

For a complete instruction on how to install unit to the rack, please follow the Slide Rail Installation Guide.



At least two people are recommended for mounting process.

10. Install 3.5" Drives to the enclosure as illustrated:

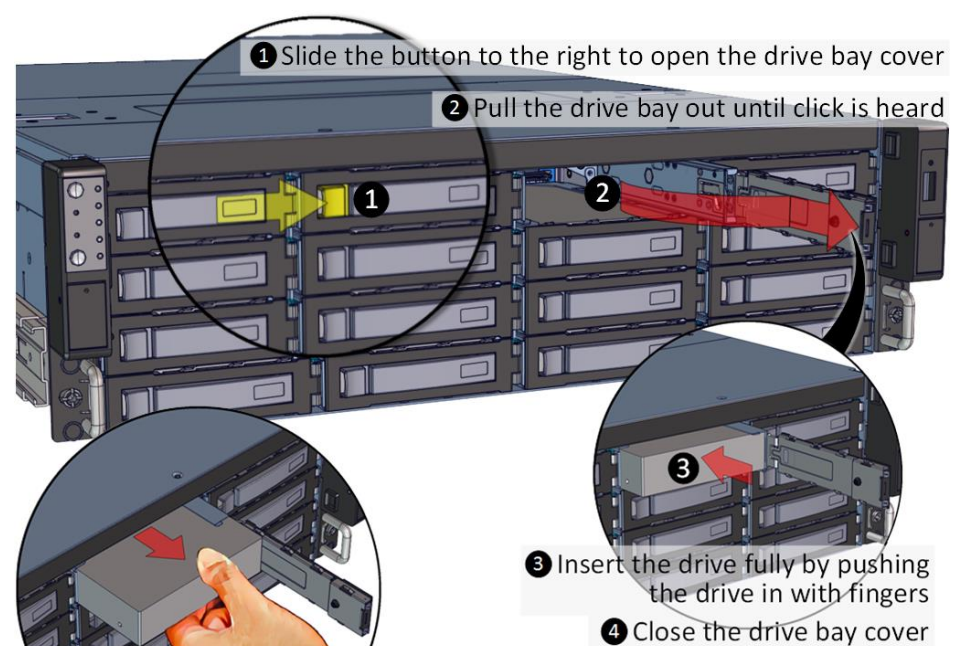

To remove the disk, open the drive bay cover, pull the handle out so that disk slightly slide out, and pull out the disk with hand.

11. Install 2.5" Drives to the enclosure as illustrated:

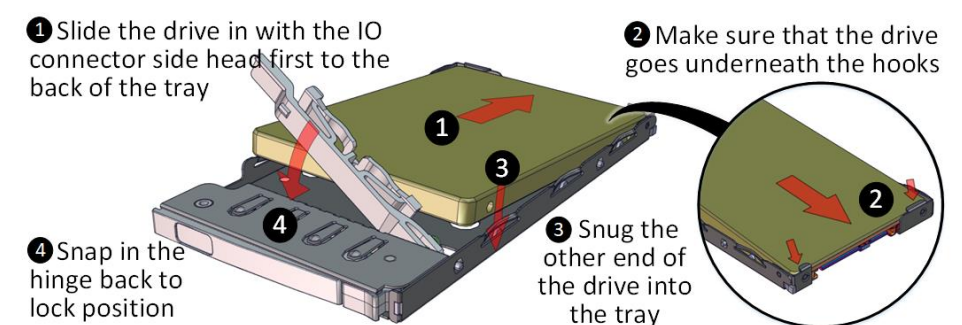

12. Plug in the Power Cords to the AC receptacles on the back of the unit.



13. Press the Power Button on the front of the unit and for the system to boot up.



14. Access the Serial Console (when necessary) by

connecting a serial audio cable to the console ports. See picture for detail. Use a terminal console with baud set 115200, 8, N, 1, N. Type "help -a" for a list of commands.

